

HiFi ENGINE[®]

For more Hi-Fi manuals and set-up information
please visit www.hifiengine.com

AM-U310

STEREO INTEGRATED AMPLIFIER

- Note:** • This manual is applicable to both silver and pearl shadow panel models.
- Remarque:** • Ce manuel s'applique aussi aux modèles avec panneaux argent et gris perle.
- Opmerking:** • Deze gebruiksaanwijzing is van toepassing op modellen met zilver en parel-grijs paneel.
- Anmärkning:** • Bruksanvisningen gäller både för modellen med silverpanel och modellen med pärlgra panel.
- Anmerkung:** • Diese Betriebsanleitung gilt auch für die Ausführung mattsilber und perlschattenfarbig.
- Nota:** • Este manual cubre ambos modelos, el de panel plateado y el de panel color perla oscura.

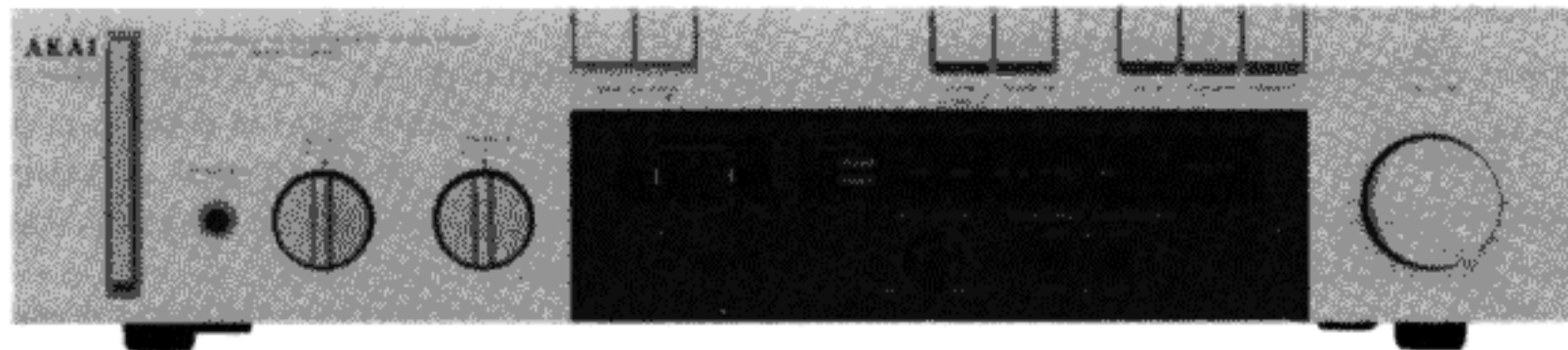

WARNING

To prevent fire or shock hazard, do not expose this appliance to rain or moisture.

| | |
|--------------------------------------|---------------------|
| Operator's Manual | Page 1-7 |
| Manuel de l'utilisateur | Page 8-13 |
| Gebruiksaanwijzing | Blz 14-19 |
| Bruksanvisning | Sid 20-25 |
| Bedienungsanleitung | Seite 26-31 |
| Manual del usuario | Pagina 32-37 |

AKAI

Operator's Manual

WARNING

POWER REQUIREMENTS

Power requirements for electrical equipment differ from area to area.

Please ensure that your machine meets the power requirements in your area.

If in doubt, consult a qualified electrician.

120V, 60 Hz for USA and Canada

220V, 50 Hz for Europe except UK

240V, 50 Hz for UK and Australia

110V/220V/240V, 50/60 Hz internally switchable for other countries.

VOLTAGE CONVERSION

Do not attempt this conversion yourself.

Models for Canada, USA, Europe, UK and Australia are not equipped with this facility.

Each machine is preset at the factory according to destination, but some machines can be set to 110V, 220V or 240V as required. If your machine's voltage can be converted, refer the following voltage conversion to a qualified Service Repair Shop or professional service personnel.

1. Disconnect the power cord.
2. Loosen the holding screws and remove the top panel.
3. Remove the Line Voltage Fuse and insert the required Line Voltage Fuse onto the proper Fuse Holder, explicitly following the printed instructions.

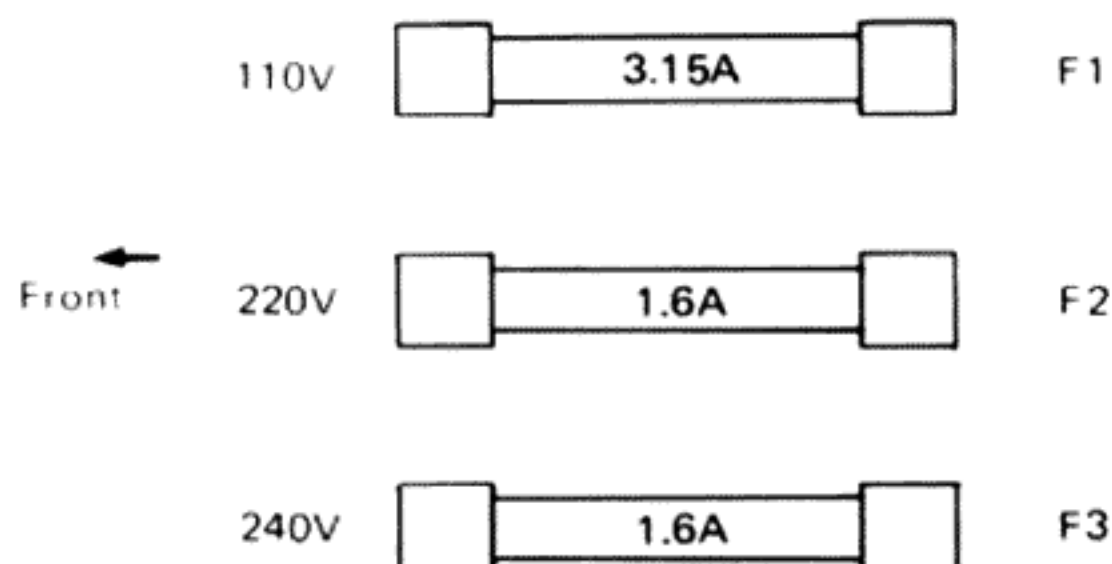



CAUTION
RISK OF ELECTRIC SHOCK
DO NOT OPEN



**CAUTION: TO REDUCE THE RISK OF ELECTRIC SHOCK, DO NOT REMOVE COVER (OR BACK).
NO USER-SERVICEABLE PARTS INSIDE.
REFER SERVICING TO QUALIFIED SERVICE PERSONNEL.**



The lightning flash with arrowhead symbol superimposed across a graphical representation of a person, within an equilateral triangle, is intended to alert the user of the presence of uninsulated "dangerous voltage" within the product's enclosure; that may be of sufficient magnitude to constitute a risk of electric shock to persons.



The exclamation point within an equilateral triangle is intended to alert the user of the presence of important operating and maintenance (servicing) instructions in the literature accompanying the appliance.

PRECAUTIONS

1. Use only household AC power sources. Never use DC power sources.
2. Touching the plug with wet hands risks dangerous electric shocks. Always pull out by the plug and never the cord.
3. Make sure the power consumption to each audio component does not exceed wattage specified. Only connect other audio components.
4. Only let a qualified professional repair or reassemble the equipment. An unauthorized person may touch the internal parts and receive a serious electric shock.
5. Never allow a child to put anything, especially metal into this equipment. A serious shock or malfunction may occur.
6. If water is spilled on this equipment, disconnect and call your dealer.
7. Make sure the equipment is well ventilated and away from direct sunlight.
8. Keep away from heat (stoves, etc.) to avoid damage to the external surface and internal circuits.
9. Avoid spray-type insecticides which will damage the equipment and may ignite suddenly.
10. To avoid damaging the finish never use alcohol, paint thinner or other similar chemicals.
11. Always place the equipment on a flat and solid surface.
12. Please read this manual in its entirety and keep it handy for further reference.

FOR CUSTOMERS IN THE UK IMPORTANT FOR YOUR SAFETY

The flex supplied with your machine will have either two wires or three as shown in the illustrations.

THREE CORE FLEX

WARNING THIS APPARATUS MUST BE EARTHED. IMPORTANT

The wires in this mains lead are coloured in accordance with the following code:

Green-and-yellow: Earth
Blue: Neutral,
Brown: Live

As the colours of the wires in the mains lead of this apparatus may not correspond with the coloured markings identifying the terminals in your plug, proceed as follows:

The wire which is coloured green-and yellow must be connected to the terminal which is marked with the letter E or by the safety earth symbol \equiv or coloured green or coloured green-and-yellow.

The wire which is coloured blue must be connected to the terminal which is marked with the letter N or coloured black.

The wire which is coloured brown must be connected to the terminal which is marked with the letter L or coloured red.

TWO CORE FLEX

IMPORTANT

The wires in this mains lead are coloured in accordance with the following code:

Blue: Neutral,
Brown: Live

As the colours of the wires in the mains lead of this apparatus may not correspond with the coloured markings identifying the terminals in your plug, proceed as follows:

The wire which is coloured blue must be connected to the terminal which is marked with the letter N or coloured black.

The wire which is coloured brown must be connected to the terminal which is marked with the letter L or coloured red.

* Do not connect any wire to the larger pin marked E or \equiv when wiring a plug.

Ensure that all terminals are securely tightened and that no loose strands of wire exist.

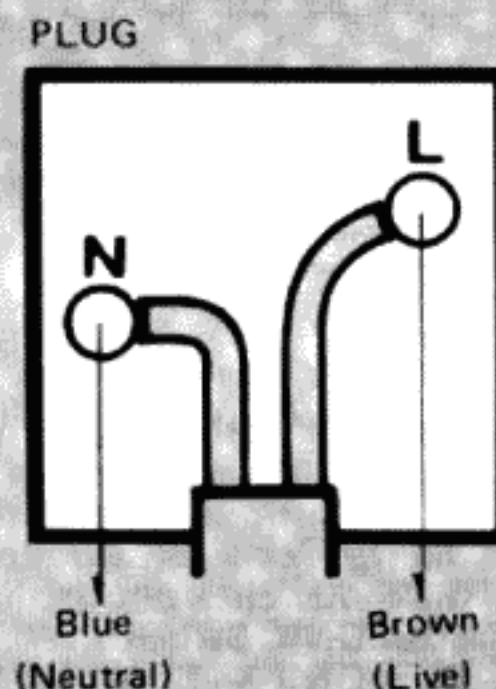
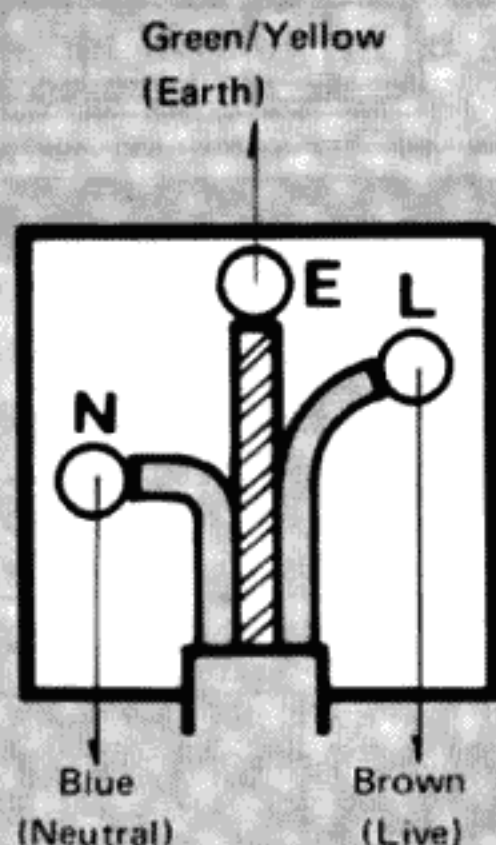

FOR CUSTOMERS IN THE U.S.A.

SAFETY INSTRUCTIONS

1. Read Instructions — All the safety and operating instructions should be read before the equipment is operated.
2. Retain Instructions — The safety and operating instructions should be retained for future reference.
3. Heed Warnings — All warnings on the equipment and in the operating instructions should be adhered to.
4. Follow Instructions — All instructions for operating and use should be followed.
5. Water and Moisture — The equipment should not be used near water — for example, near a bathtub, washbowl, kitchen sink, laundry tub, in a wet basement, or near a swimming pool, etc.
6. Carts and Stands — The equipment should be used only with a cart or stand that is recommended by Akai.
7. Wall or Ceiling Mounting — Akai does not recommend mounting the equipment on a wall or a ceiling.
8. Ventilation — The equipment should be situated so that its location or position does not interfere with its proper ventilation. For example, the equipment should not be situated on a bed, sofa, rug, or similar surface that may block the ventilation openings; or, placed in a built-in installation, such as a bookcase or cabinet that may impede the flow of air through the ventilation openings.
9. Heat — The equipment should be situated away from heat sources such as radiators, heat registers, stoves, or other equipments (including amplifiers) that produce heat.
10. Power Sources — The equipment should be connected to a power supply only of the type described in the operating instructions or as marked on the equipment.
11. Grounding or Polarization — The precautions should be taken so that the grounding or polarization means of an equipment is not defeated.
12. Power-Cord Protection — Power-supply cords should be routed so that they are not likely to be walked on or pinched by items placed upon or against them, paying particular attention to cords at plugs, convenience receptacles, and the point where they exit from the equipment.
13. Cleaning — The equipment should be cleaned only as recommended by the manufacturer.
14. Power Lines — An outdoor antenna should be located away from power lines.
15. Outdoor Antenna Grounding — If an outside antenna is connected to the receiver, be sure the antenna system is grounded so as to provide some protection against voltage surges and built up static charges. Section 810 of the National Electrical Code, ANSI/NFPA No. 70-1981, provides information with respect to proper grounding of the mast and supporting structure, grounding of the lead-in wire to an antenna discharge unit, size of grounding conductors, location of antenna-discharge unit, connection to grounding electrodes, and requirements for the grounding electrode. See Figure 1.
16. Nonuse Periods — The power cord of the equipment should be unplugged from the outlet when left unused for a long period of time.
17. Object and Liquid Entry — Care should be taken so that objects do not fall and liquids are not spilled into the enclosure through openings.
18. Damage Requiring Service — The equipment should be serviced by qualified service personnel when:
 - A. The power-supply cord or the plug has been damaged; or
 - B. Objects have fallen, or liquid has been spilled into the equipment; or
 - C. The equipment has been exposed to rain; or
 - D. The equipment does not appear to operate normally or exhibits a marked change in performance; or
 - E. The equipment has been dropped, or the enclosure damaged.
19. Servicing — The user should not attempt to service the equipment beyond that described in the operating instructions. All other servicing should be referred to qualified service personnel.

Fig. 1

EXAMPLE OF ANTENNA GROUNDING AS PER NATIONAL ELECTRICAL CODE INSTRUCTIONS

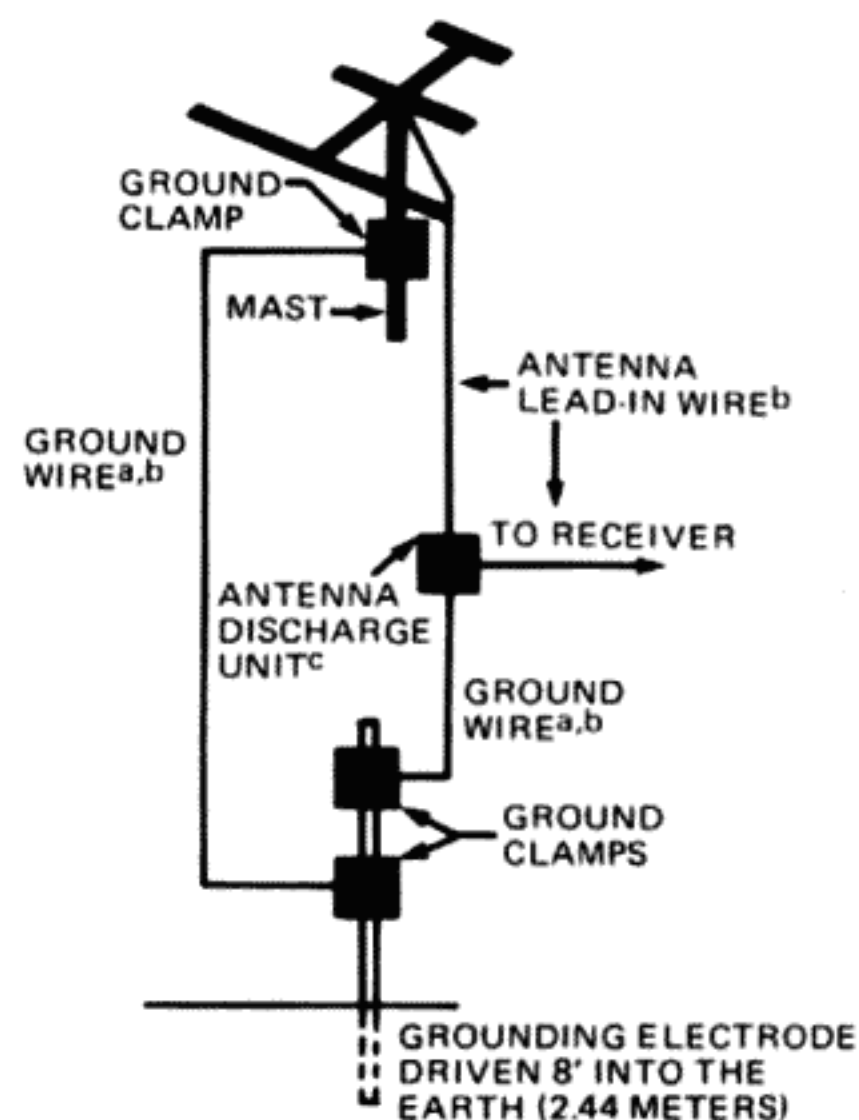

- a. Use No. 10 AWG (5.3 mm²) copper, No. 8 AWG (8.4 mm²) aluminum, No. 17 AWG (1.0 mm²) copper-clad steel or bronze wire, or larger, as ground wire.
- b. Secure antenna lead-in and ground wires to house with stand-off insulators spaced from 4 feet (1.22 m) to 6 feet (1.83 m) apart.
- c. Mount antenna discharge unit as close as possible to where lead-in enters house.

FOR CUSTOMERS IN AUSTRALIA

If your machine comes with a three core power cord, FOR YOUR SAFETY:

1. Insert this plug only into an effectively earthed three-pin plug socket outlet.
2. If any doubt exists regarding the earthing, consult a qualified electrician.
3. Extension cords, if used, must be three-core correctly wired.

CONTROLS

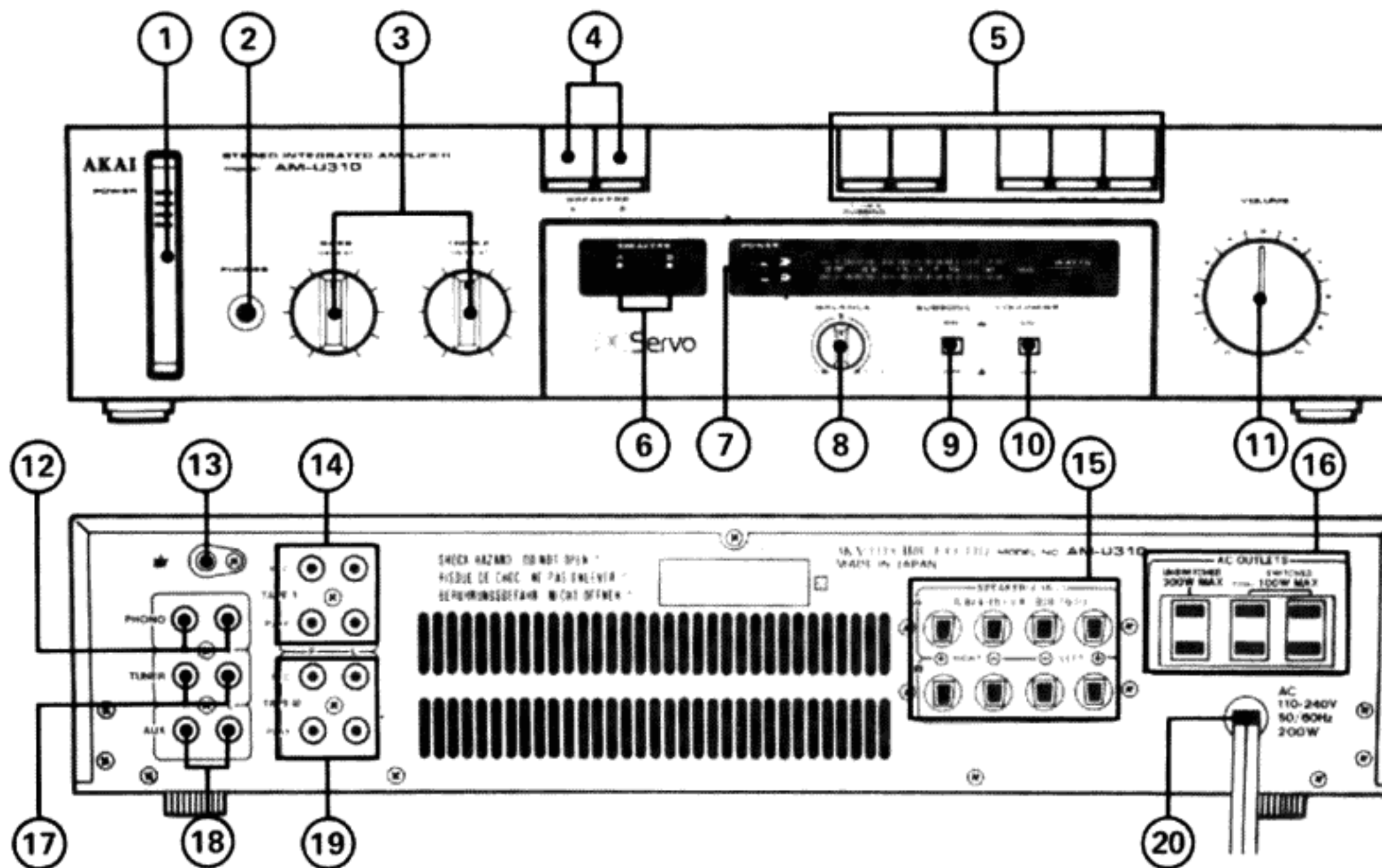

1. POWER Switch

Depress to turn on the power and depress again to turn off the power. Depress only the upper part of the switch (near the word POWER).

2. Headphone Jack (PHONES)

Accommodates 8 ohm low impedance type stereo headphones for monitoring or private headphone listening.

3. Tone Controls

* Set to DEFEAT for flat frequency response with no tone control effect.

BASS: For low range frequency response control. Can be adjusted from -8 dB to +8 dB.

TREBLE: For high range frequency response control. Can be adjusted from -8 dB to +8 dB.

4. SPEAKERS Switches

A: Depress the switch to listen through speakers connected to the rear panel A SPEAKER terminals.

B: Depress the switch to listen through speakers connected to the rear panel B SPEAKER terminals.

Depress both switches to listen through two sets of speakers connected to both A and B SPEAKER terminals.

* A and B SPEAKER terminals accommodate speakers of 4 to 16 ohm impedance, but if both A and B SPEAKER terminals are used simultaneously, speakers of 8 to 16 ohm impedance must be used.

5. Input Selector Switches with Indicators

* When a switch is turned on, its indicator will light.

TAPE-1: Turn on the switch for input from a tape deck connected to the rear panel TAPE 1 jacks.

TAPE-2: Turn on the switch for input from a tape deck connected to the rear panel TAPE 2 jacks.

1 → 2 DUBBING: Set the tape deck connected to the TAPE 1 jacks to playback mode and set the tape deck connected to the TAPE 2 jacks to recording mode for tape dubbing. Turn on only the TAPE-1 switch.

AUX: Turn on the switch for input from a tape deck or a crystal or ceramic type cartridge turntable or other external source connected to the rear panel AUX jacks.

TUNER: Turn on the switch for input from a tuner connected to the rear panel TUNER jacks.

PHONO: Turn on the switch for input from a magnetic type cartridge turntable connected to the rear panel PHONO jacks.

6. SPEAKERS A and B Indicators

Will light depending on which SPEAKERS switch is depressed.

7. FLD POWER Indicator (LEFT/RIGHT)

Indicates the output level for both left and right channels.

8. Stereo BALANCE Control

For left and right speaker balance. Turning clockwise reduces the volume of the left channel and turning counterclockwise reduces the volume of the right channel. Output of left and right channels is equal when set to the center click position.

9. SUBSONIC Switch

Turn ON (▲) the switch to eliminate low frequency disturbances such as turntable rumble, etc.

10. LOUDNESS Switch

When listening at a low volume level, the range audible by the human ear is limited. The loudness circuit supplements this range by boosting the bass and treble response. Turn ON (▲) the switch for balanced sound at low volume.

11. VOLUME Control

For volume adjustment. Turn clockwise to increase volume.

12. PHONO Jacks

Connect to the outputs of magnetic type cartridge turntable.

* Use AUX jacks for connection of crystal or ceramic type cartridge turntable.

13. Ground Terminal (⏏)

Connect to the Ground terminal of turntables, tape decks, etc.

* When connecting a turntable connect the ground wire to the Ground terminal.

14. TAPE 1 REC/PLAY Jacks

For connection to a tape deck or recorder for recording/playback.

REC: Connects to the inputs of tape deck for recording.

PLAY: Connects to the outputs of tape deck for playback.

15. A and B SPEAKER System Terminals

Be sure to match plus and minus and left and right. If plus and minus terminals are reversed, poor and unnatural sound will result.

16. AC OUTLETS (Some models are not equipped with this facility.)

UNSWITCHED Outlet: Not inter-connected with the front panel POWER switch. Power is supplied even when the AM-U310 is turned off. 300W MAX.

SWITCHED Outlets: Inter-connected with the front panel POWER switch. Power is cut when the AM-U310 is turned off. TOTAL 100W MAX.

17. TUNER Jacks

Connect to the outputs of tuner.

18. AUX Jacks

For connection of relatively high output components such as a crystal or ceramic type cartridge turntable or a tape deck or recorder.

19. TAPE 2 REC/PLAY Jacks

20. Power Cord

CONNECTIONS

ATTENTION

- * Turn off all the components before connecting.
- * A and B SPEAKER terminals accommodate speakers of 4 to 16 ohm impedance, but if both A and B SPEAKER terminals are used simultaneously, speakers of 8 to 16 ohm impedance must be used.
- * Connect so that the live part of the speaker wire cannot be touched.

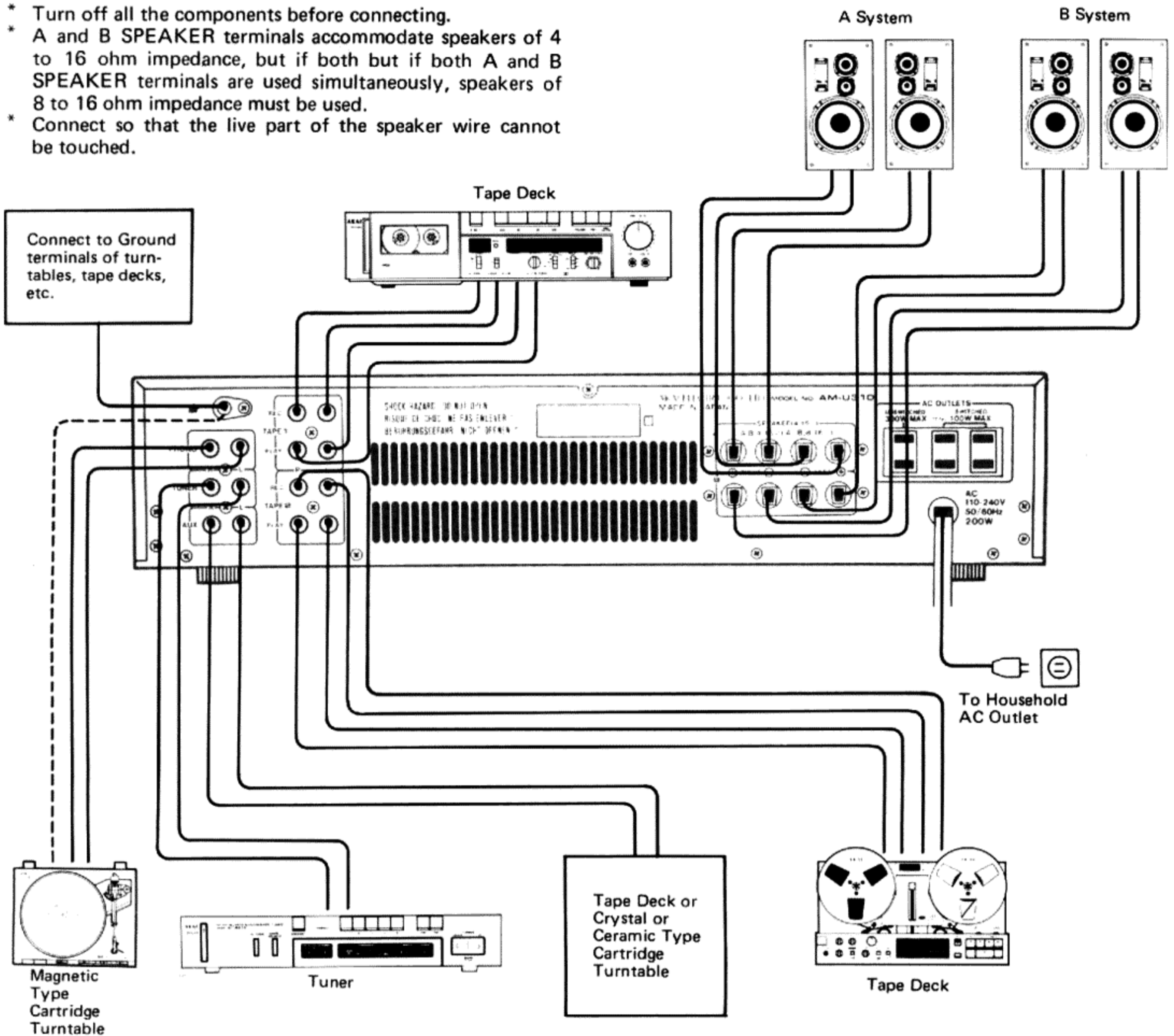

HOW TO CONNECT SPEAKERS

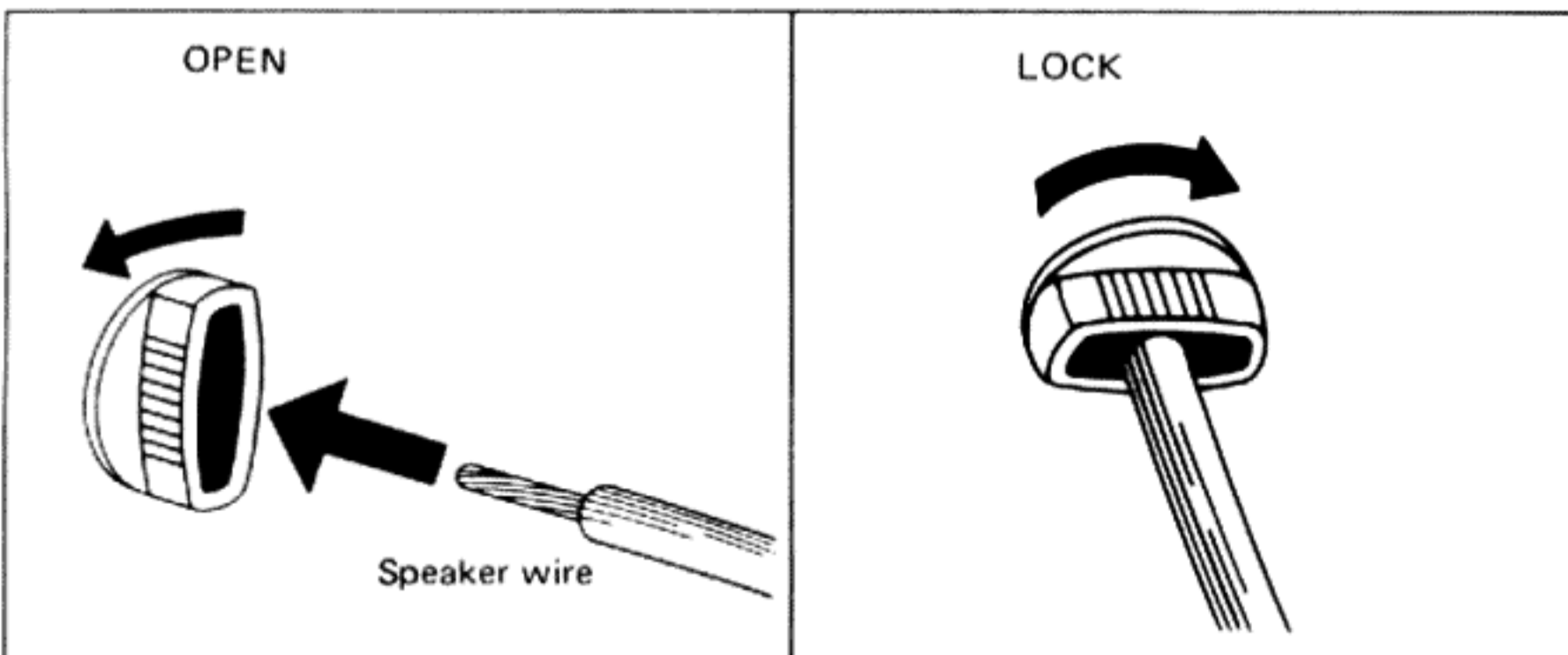

1. Strip over 1 cm length of vinyl covering from the end of the speaker wire.
 2. Open the terminal and insert the wire into the terminal.
 3. Turn the terminal clockwise to lock.
 4. Pull the wire to make sure that the wire is secure.
- * Be sure to match the plus and minus and left and right. If the plus and minus terminals are reversed, poor and unnatural sound will result.

OPERATIONS

PLAYBACK

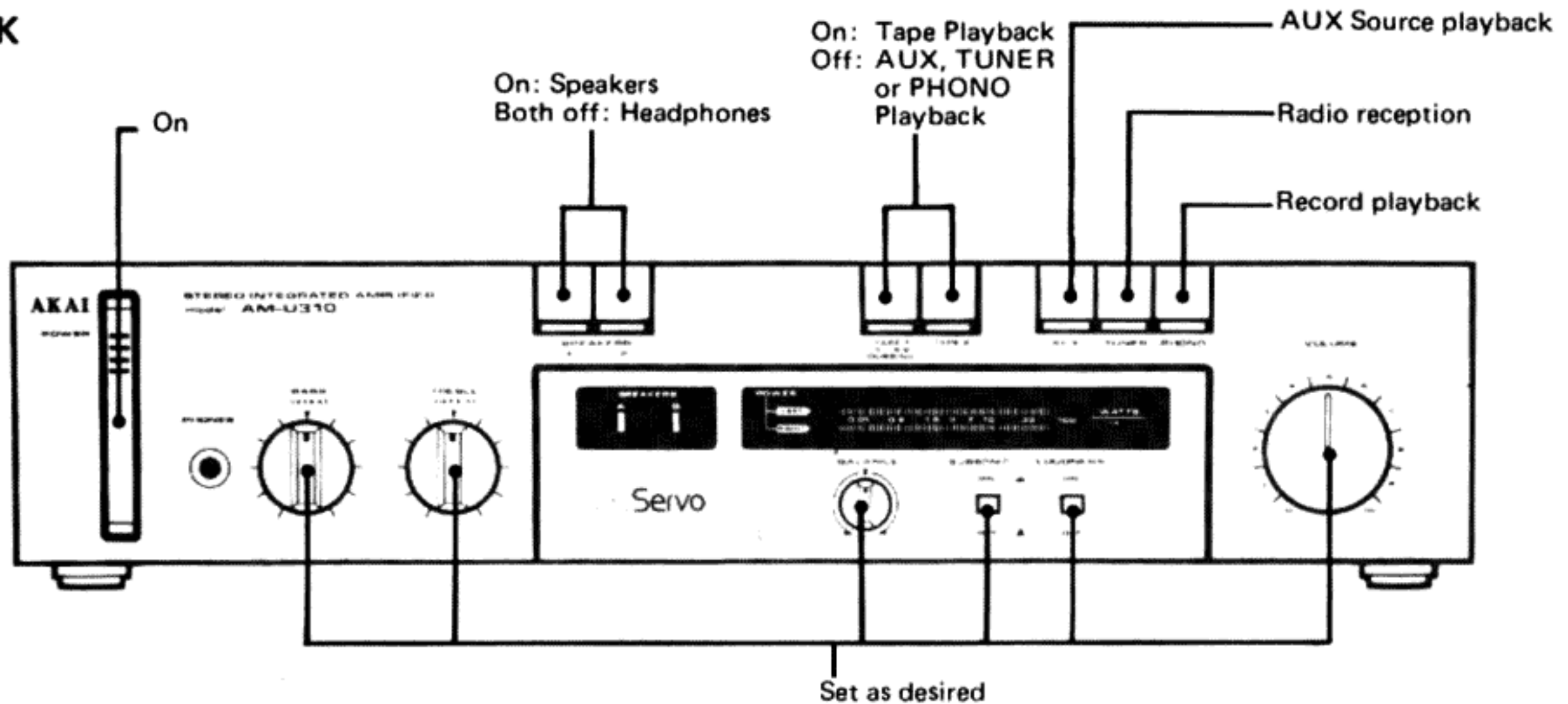

BEFORE OPERATION:

- Set the **SPEAKERS** switches.
- Lower the **VOLUME** control.
- Set the **Tone** controls and **SUBSONIC** and **LOUDNESS** switches to **DEFEAT** and **OFF** () respectively.
- Turn off (the indicator is off) the **TAPE-1** and **-2** switches to monitor source signals.

DEPRESS THE POWER SWITCH TO TURN ON THE POWER.

● RECORD PLAYBACK

1. Depress the **PHONO** switch.
2. Set the turntable to playback mode.
3. Adjust the **VOLUME**, **BALANCE**, **BASS** and **TREBLE** controls.
4. Depress the **SUBSONIC** and **LOUDNESS** switches as desired.

CAUTION: Do not connect a crystal or ceramic type cartridge turntable to the **PHONO** jacks. When using this type of turntable, employ the **AUX** jacks and depress the **AUX** switch.

- * When a pick-up ground line is available, connect to the **Ground** () terminal.
- * Avoid placing the turntable too close to the speaker system. If placed too close, transmission of vibration from the speakers will cause howling.
- * Confirm that the connections are complete and that the thickness of wire is sufficient. Incorrect or incomplete wiring is, in some cases, the cause of hum.

TROUBLE SHOOTING

HUM OR BUZZ WHEN PLAYING RECORDS

- * Check to see if the connections are correct and are not loose.
- * Check for correct grounding.
- * Shielded wire is away from fluorescent lamps.

POOR TONALITY OR NOISY SOUND

- * Worn out stylus or record must be replaced.
- * Check to see if the stylus or record is clean.
- * Pressure of stylus must be properly set.

● RADIO RECEPTION

1. Depress the **TUNER** switch.
2. Set the tuner to receive **FM** or **AM** broadcast.
3. Adjust the **VOLUME**, **BALANCE**, **BASS** and **TREBLE** controls.
4. Depress the **SUBSONIC** and **LOUDNESS** switches as desired.

● TAPE PLAYBACK

1. Depress the **TAPE-1** or **-2** switch depending on the tape deck to be played back.
 2. Set the tape deck to playback mode.
 3. Adjust the **VOLUME**, **BALANCE**, **BASS** and **TREBLE** controls.
 4. Depress the **SUBSONIC** and **LOUDNESS** switches as desired.
- * The **AUX** jacks can also be used for playback. In such a case, depress the **AUX** switch. Confirm that both the **TAPE-1** and **-2** switches are turned off.

OPERATIONS

RECORDING

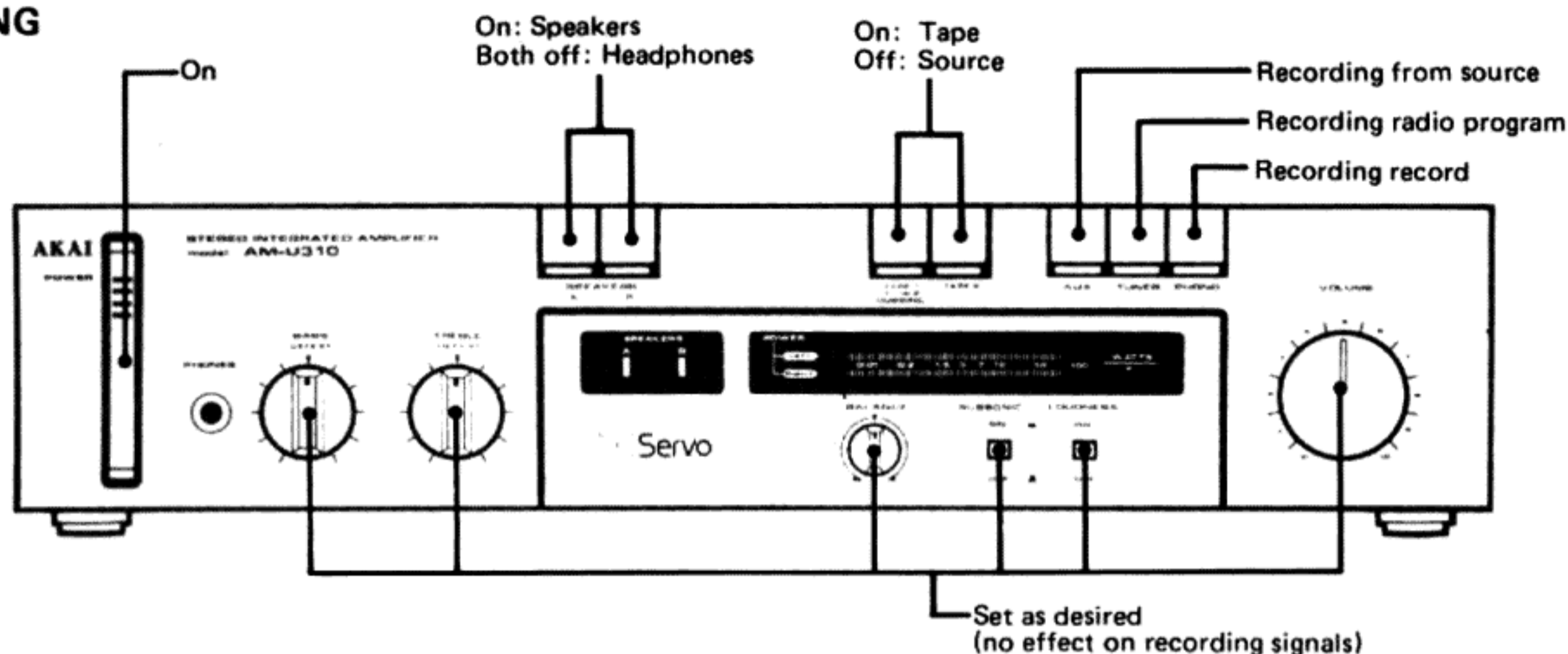

BEFORE OPERATION:

- Set the **SPEAKERS** switches.
- Turn off (the indicator is off) the **TAPE-1** and **-2** switches to monitor source signals.

DEPRESS THE POWER SWITCH TO TURN ON THE POWER.

● RECORDING FROM SOURCE

1. Depress the **AUX**, **TUNER** or **PHONO** switch according to the source.
 2. Put the tape deck into recording standby mode.
 3. Playback the source equipment and adjust the tape deck's recording level.
 4. Set the source equipment ready to playback from the beginning.
 5. Playback the source equipment and put the tape deck into recording mode.
- * The **VOLUME**, **BALANCE**, **BASS** and **TREBLE** controls can be adjusted and the **SUBSONIC** and **LOUDNESS** switches can be set during recording but they will have no effect on the recording signals.

MONITORING (Comparison of the source signals to the just recorded signals)

Possible only with a 3 headed tape deck.

1. Set the **Tape Monitor** switch of the tape deck to the **Tape** position.
2. Turn on the **TAPE-1** or **-2** switch, according to the tape deck being used, to monitor the just recorded signals.
3. Turn off both the **TAPE-1** and **-2** switch to monitor the source signals.

● TAPE DUBBING

From TAPE-1 to TAPE-2

1. Turn on the TAPE-1 switch and turn off the TAPE-2 switch.
2. Put the tape deck connected to the TAPE-2 jacks to recording standby mode.
3. Put the tape deck connected to the TAPE-1 jacks to playback mode.
4. Adjust the recording tape deck's recording input levels.
5. Set the playback tape deck ready to play back from the beginning.
6. Play back the playback tape deck and put the recording tape deck into recording mode.

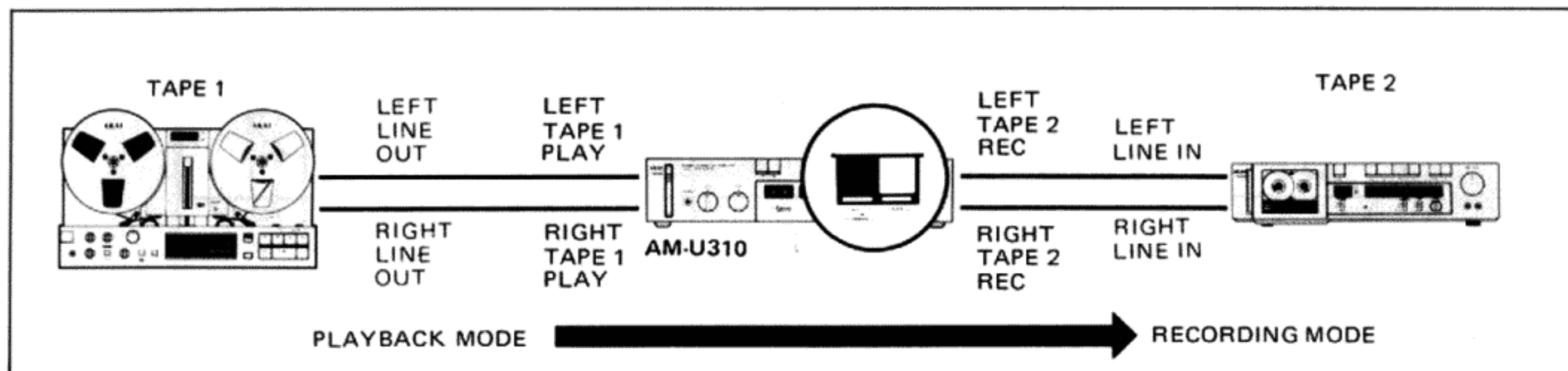

Using AUX Jacks

1. Connect a tape deck to the AUX jacks and another tape deck(s) to the TAPE-1 or (and) TAPE-2 jacks.
2. Depress the AUX switch.
3. Put the tape deck(s) connected to the TAPE-1 or (and) TAPE-2 jacks to recording standby mode.
4. Play back the tape deck connected to the AUX jacks and adjust the recording tape deck(s)'s recording level.
5. Set the playback tape deck ready to play back from the beginning.
6. Play back the playback tape deck and put the recording tape deck(s) into recording mode.

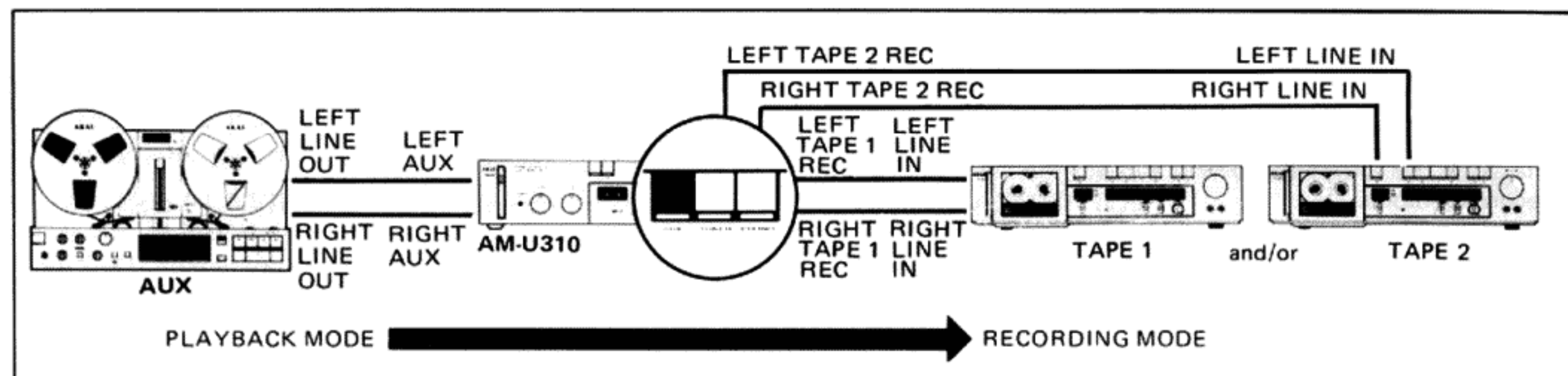

SPECIFICATIONS

| | | | |
|---|---|---|---|
| Rated Power Output (Both Channels Driven) | | Frequency Response | |
| 20 Hz to 20 kHz, 8 ohms | .40W x 2/0.03% | PHONO (RIAA Deviation) | ±0.5 dB |
| 20 Hz to 20 kHz, 4 ohms | .50W x 2/0.06% | TUNER, AUX, TAPE 1, 2 | 5 Hz to 100 kHz (-3 dB) |
| Power Bandwidth (IHF -3 dB, 8 ohms) | | Tone Control | |
| | 5 Hz to 60 kHz (0.1%) | Bass | ±8 dB (100 Hz) |
| Signal to Noise Ratio (IHF-A) | | Treble | ±10 dB (10 kHz) |
| PHONO to SPEAKER | .80 dB | Loudness Control | +10 dB (100 Hz) |
| TUNER, AUX, | | (Volume set at -30 dB | +6 dB (10 kHz) |
| TAPE 1, 2 to SPEAKER | .100 dB | position) | |
| Residual Noise (8 ohms) | .150 μV | Subsonic Filter | -3 dB/Oct at 18 Hz |
| Channel Separation | .60 (1 kHz)/60 (40 Hz)/50 (10 kHz) | Power requirements | .120V, 60 Hz for USA and Canada 220V, 50 Hz for Europe except UK 240V, 50 Hz for UK and Australia 110V/220V/240V, 50/60 Hz switchable for other countries. |
| Damping Factor (8 ohms) | .60 (1 kHz)/60 (40 Hz)/52 (12.5 kHz) | Dimensions | .440(W) x 100(H) x 312(D) mm (17.3 x 3.9 x 12.3 inches) |
| Output | | Weight | .61 kg (13.4 lbs) |
| Required Speaker | | STANDARD ACCESSORIES | |
| Impedance | A, B: 4 to 16 ohms A + B: 8 to 16 ohms | Operator's Manual | 1 |
| Input Sensitivity | | * For improvement purposes, specifications and design are subject to change without notice. | |
| PHONO MM | .25 mV/47 kohms | | |
| TUNER, AUX, TAPE 1, 2 | .150 mV/100 kohms | | |
| Output Level/Impedance | | | |
| TAPE REC 1, 2 | .150 mV | | |
| PHONO Maximum Input Level (1 kHz) | | | |
| MM | .150 mV | | |

AKAI

AKAI ELECTRIC CO., LTD.

12-14, 2-chome, Higashi-Kojima,
Ohta-ku, Tokyo, Japan

2

Printed in Japan
①561113D2 561204 - 03